

1st EDITION

SCISSORS UP CUT GENERAL
TUNGSTEN CARBIDE UP CERAMIC
ORTHO NEURO SPINE ENT CARDIOLOGY
ELECTRO SURGICAL GYNAECOLOGY
LAPROSCOPY TITANUM

We shape the steel to serve humanity...



DOLPHIN
INSTRUMENTS

ISO 9001:2008 Certified Company
WHO GMP Company



www.dolphinsurgicals.com



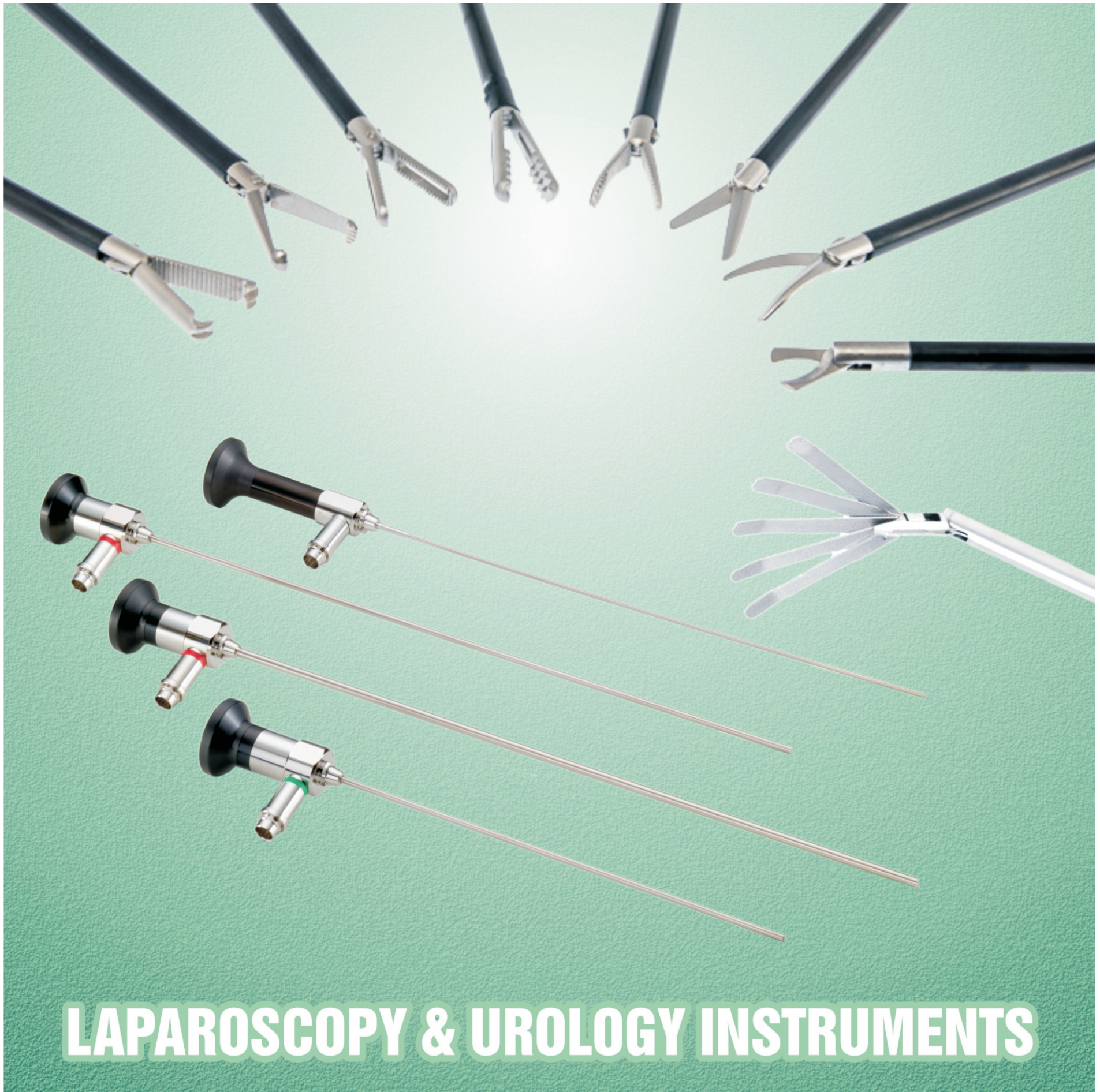

LAPAROSCOPY & UROLOGY INSTRUMENTS

BIPOLAR & MONOPOLAR CABLE



**Silicone Patient Plate
(For Padareatric, Small Children)**

DI - 23 Size: 6" / 4"

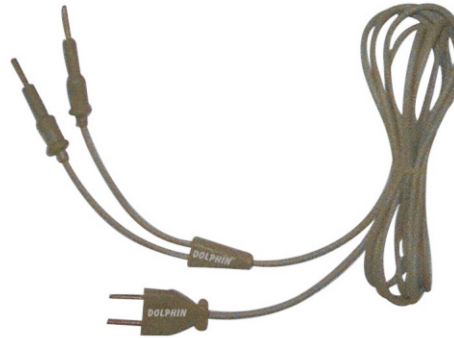

**Patient Plate Cable Cord
with Connector**

DI - 24

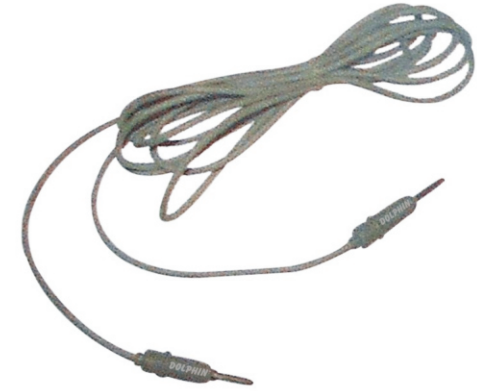

**Monopolar Active Handle
Cable Card**

DI - 25



**Monopolar Active
Handle Cable Card**

DI - 26

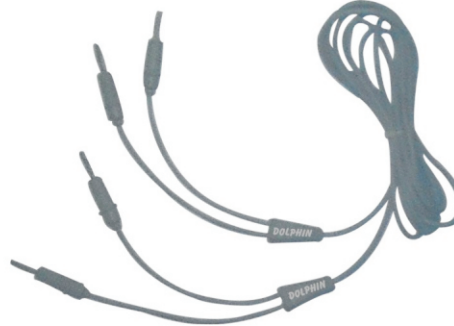

Patient Plate Cable Cord

DI - 27



Patient Plate Cable Cord (Regular)

DI - 28



**Patient Plate Cable Cord
(Silicon Flat Cable)**

DI - 29



**Monopolar Laparoscopy
Forceps Cable Cord**

DI - 39



**Bipolar Laparoscopy
Forceps Cable Cord**

DI - 40

BIPOLAR & MONOPOLAR CABLE

DOLPHIN
INSTRUMENTS

LAPAROSCOPY & UROLOGY INSTRUMENTS



Bipolar Cable Cord
DI - 41



Bipolar Cable Cord
DI - 42

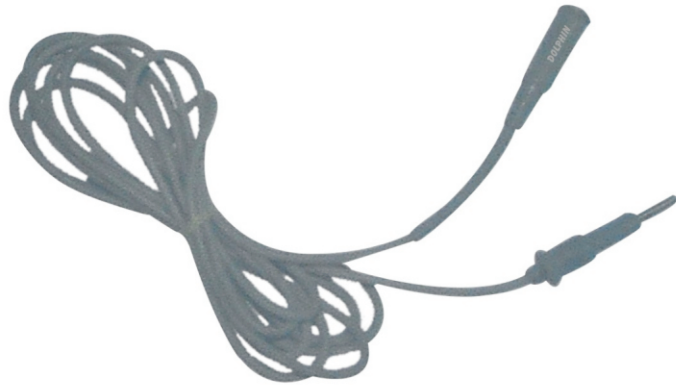

Monopolar Forceps Cable Cord
DI - 43



**Bipolar Forceps Cable Cord
(European Type)**
DI - 44



Bipolar Forceps Cable Cord
DI - 45



**Bipolar Cable Cord with
L & T Connector**
DI - 46

LAPAROSCOPE INSTRUMENTS



0° Laparoscope
Ø 10 x 330 mm
Ø 5 x 330 mm

Autoclave



30° Laparoscope
Ø 10 x 330 mm
Ø 5 x 330 mm

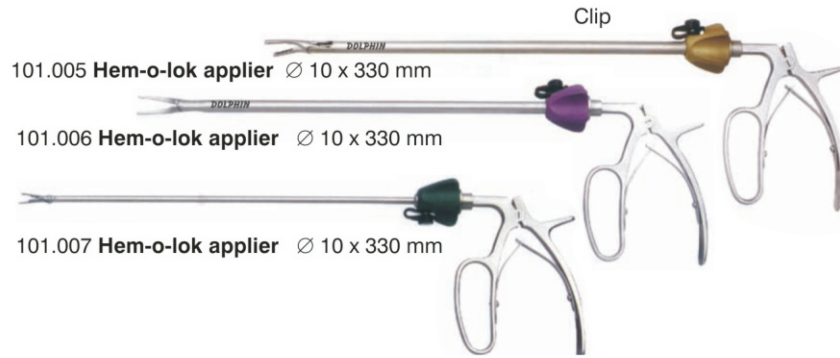

101.005 Hem-o-lok applier Ø 10 x 330 mm
101.006 Hem-o-lok applier Ø 10 x 330 mm
101.007 Hem-o-lok applier Ø 10 x 330 mm

Clip



101.005 Hem-o-lok applier (XL)
Ø 10 x 330 mm
101.006 Hem-o-lok applier (M)
Ø 10 x 330 mm
101.007 Hem-o-lok applier (S)
Ø 10 x 330 mm



101.180
Ø 5.5 x 3330 mm
Clip remover
(Hem - o - lok L Size)

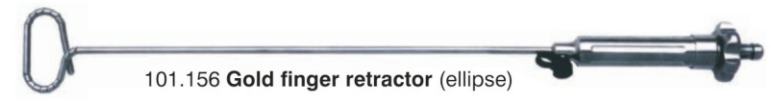

101.156 Gold finger retractor (ellipse)



101.157 Gold Finger Retractor (semi-circle)



101.158 Gold Finger Retractor (square-circle)



101.159 Gold Finger Retractor (large type)

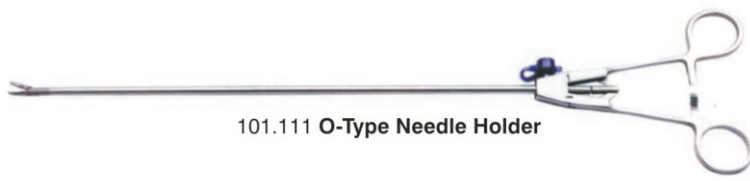

101.111 O-Type Needle Holder



101.108 V-Type Needle Holder

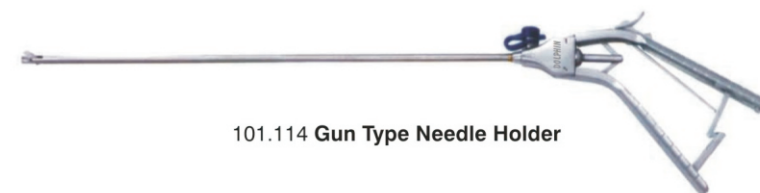

101.114 Gun Type Needle Holder



101.111 Straight Jaw



101.112 Curved Jaw (Right - Left)



101.107 Automatic Resetting



101.107 Reset Folder Line

LAPAROSCOPE INSTRUMENTS

DOLPHIN
INSTRUMENTS



D Type Handle
(3 Partition)



Straight Scissors
101.056 Ø 5 x 330 mm
101.027 Ø 2.8 x 300 mm



Straight Scissors
101.056 Ø 5 x 330 mm
102.026 Ø 2.8 x 300 mm



Curved Scissors
101.057 Ø 5 x 330 mm
102.012 Ø 2.8 x 300 mm
106.004 Ø 5 x 210 mm



Curved Scissors
101.057 Ø 5 x 330 mm
102.025 Ø 2.8 x 300 mm



Upward Scissors
101.174 Ø 5 x 330 mm



Hook Scissors
101.053 Ø 5 x 330 mm
102.013 Ø 2.8 x 300 mm
106.005 Ø 5 x 210 mm



Dissecting Forceps (Straight)
101.058 Ø 5 x 330 mm
102.014 Ø 2.8 x 300 mm
106.006 Ø 5 x 210 mm



Maryland Forceps (Curved)
101.059 Ø 5 x 330 mm
102.015 Ø 2.8 x 300 mm
106.023 Ø 5 x 210 mm



70° Dissecting Forceps
(70° Left curved)
101.175 Ø 5 x 330 mm



Dissecting Forceps
(90° Curved) (70° Left Curved)
101.175 Ø 5 x 330 mm



Grasping Forceps
Large jaw/toothless
101.173 Ø 5 x 330 mm



Duck Jaw Forceps
101.067 Ø 5 x 330 mm
102.002 Ø 2.8 x 300 mm
101.018 Ø 10 x 330 mm



Atraumatic Forceps
101.065 Ø 5 x 330 mm
102.007 Ø 2.8 x 330 mm



Atraumatic Forceps
101.066 Ø 5 x 330 mm
102.008 Ø 2.8 x 330 mm



Maxi Forceps
101.083 Ø 5 x 330 mm
102.003 Ø 2.8 x 330 mm
106.010 Ø 5 x 210 mm



Reversing tooth Forceps
101.084 Ø 5 x 330 mm
102.004 Ø 2.8 x 330 mm
106.014 Ø 5 x 210 mm



Reversing tooth Forceps
(Lengthen)
101.102 Ø 5 x 330 mm



Rat jaw Forceps
(1+2 tooth in head)
101.091 Ø 5 x 330 mm



Rat Jaw Forceps
(1+2 tooth in head)
101.092 Ø 5 x 330 mm



Rat Jaw Forceps
(2+3 tooth in head)
101.090 Ø 5 x 330 mm



Bowel Forceps
101.069 Ø 5 x 330 mm



Grasping Forceps
(Central Hollow. Contrate)
101.096 Ø 5 x 330 mm



Grasping Forceps
(Fenestrated. vertical)
101.095 Ø 5 x 330 mm



O-Grasping Forceps
(Fenestrated. vertical)
101.070 Ø 5 x 330 mm



O-Grasping Forceps
(Fenestrated)
101.071 Ø 5 x 330 mm



Triporate Forceps
101.099 Ø 5 x 330 mm



Stomach Grasping Forceps
101.093 Ø 5 x 330 mm



Tally Pull Forceps
101.171 Ø 5 x 330 mm



Knot Forceps
101.074 Ø 5 x 330 mm
102.010 Ø 2.8 x 330 mm



Knot push Forceps
101.074 Ø 5 x 330 mm
102.010 Ø 2.8 x 330 mm



Grasping Forceps
101.172 Ø 5 x 330 mm



Croce Olim Forceps
(2 releasing hole)
101.098 Ø 5 x 330 mm



Bowel Forceps
101.068 Ø 5 x 330 mm

LAPAROSCOPE INSTRUMENTS



Blunt Grasping Forceps
101.064 Ø 5 x 330 mm
102.009 Ø 2.8 x 300 mm



Blunt Grasping Forceps (Rough tooth)
101.097 Ø 5 x 330 mm



Grasping Forceps (Serration)
101.101 Ø 5 x 330 mm



Grasping Forceps (Rough Tooth, Fenestrated)
101.100 Ø 5 x 330 mm



Biopsy forceps
101.089 Ø 5 x 330 mm



Appendiceal Forceps
101.085 Ø 5 x 330 mm



Biopsy Forceps (with eyetooth)
101.082 Ø 5 x 330 mm



Babcock Grasper Forceps
101.063 Ø 5 x 330 mm



Biopsy Forceps With cutting action
101.094 Ø 5 x 330 mm



Oviduct Forceps
101.081 Ø 5 x 330 mm



Mesentery Forceps
101.086 Ø 5 x 330 mm

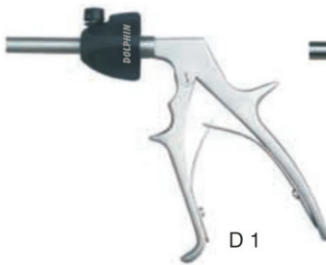

D 1

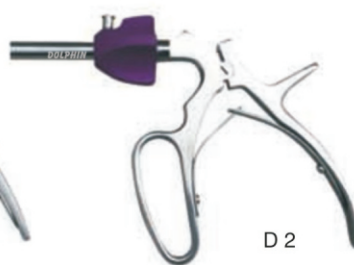

D 2



101.001 Titanium clip applier (Single action)
Ø 10 x 330 mm



102.001 Titanium clip applier (Single action)
Ø 5 x 330 mm



101.006 Hem-o-lok applier
Ø 10 x 330 mm
Ø 5 x 330 mm



101.004 Absorbable Ligating Clip Applier (Tyco Clip)
Ø 10 x 330 mm



101.003 90° Angle Titanium Clip Applier
Ø 10 x 330 mm



101.002 Double Action Titanium Clip Applier
Ø 10 x 330 mm



106.001 Deeper Titanium Clip Applier
Ø 10 x 210 mm



101.010 Lithotomy Forceps
Ø 10 x 330 mm
Ø 10 x 210 mm



101.176 Grasping Forceps
Ø 10 x 330 mm
Ø 2.8 x 300 mm



101.178 Curved Scissors
Ø 10 x 330 mm



101.015 Stomach Grasping Forceps (ball Head)
Ø 10 x 330 mm



101.020 Atraumatic Forceps
Ø 10 x 330 mm



101.013 Target Forceps
Ø 10 x 330 mm



101.179 Tight Grasping Forceps
Ø 10 x 330 mm



101.009 Babcock Grasping Forceps
Ø 10 x 330 mm



101.177 Grams Clamp Plate
Ø 10 x 330 mm



101.021 Lung Lobe Forceps
Ø 10 x 330 mm



101.018 Duck Jaw Forceps
Ø 10 x 330 mm



101.016 Vascular Occlusion Forceps
Ø 10 x 330 mm



101.017 Large Jaw Grasping Forceps
Ø 10 x 330 mm



101.019 Broadress Mouth Forceps
Ø 10 x 330 mm

LAPAROSCOPE INSTRUMENTS

DOLPHIN
INSTRUMENTS

LAPAROSCOPY & UROLOGY INSTRUMENTS

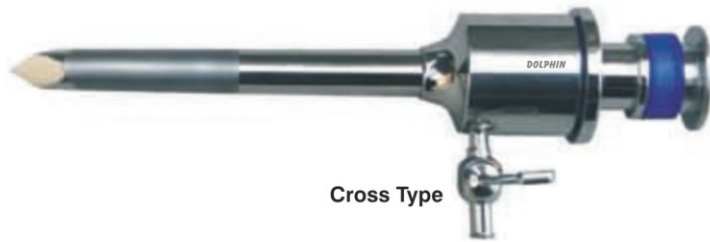

Cross Type

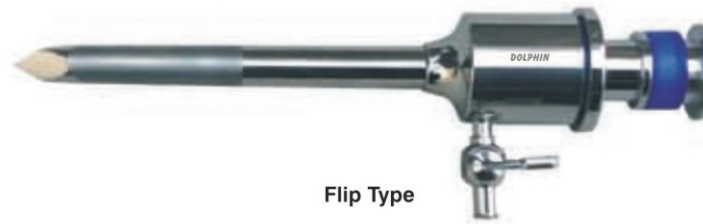

Flip Type



Cross Type

101.022 Ø 5.5 x 105 mm
101.025 Ø 10.5 x 105 mm



Cross Type with Safety

101.023 Ø 5.5 x 105 mm
101.026 Ø 10.5 x 105 mm



Cross Type with Transform

101.051 Ø 10.5 x 105 mm



Flip Type

101.035 Ø 5.5 x 105 mm
101.038 Ø 10.5 x 105 mm

101.118 **Bipolar Electrocoagulation Clip** (Plastic Handle)
Ø 5 x 330 mm

Dismantle as following steps as shown

- 1) Grip Handle and push button with thumb
- 2) Pull out clip core
- 3) Rotate reel till taking off
- 4) Pull out clip rod
- 5) Pull out Clip inner rod

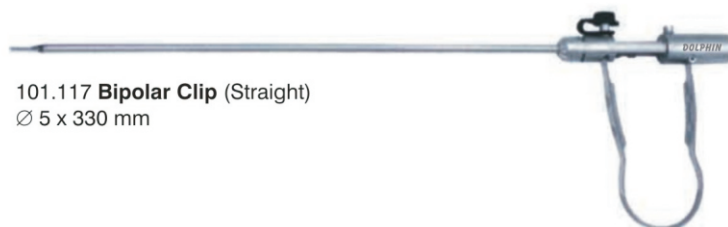
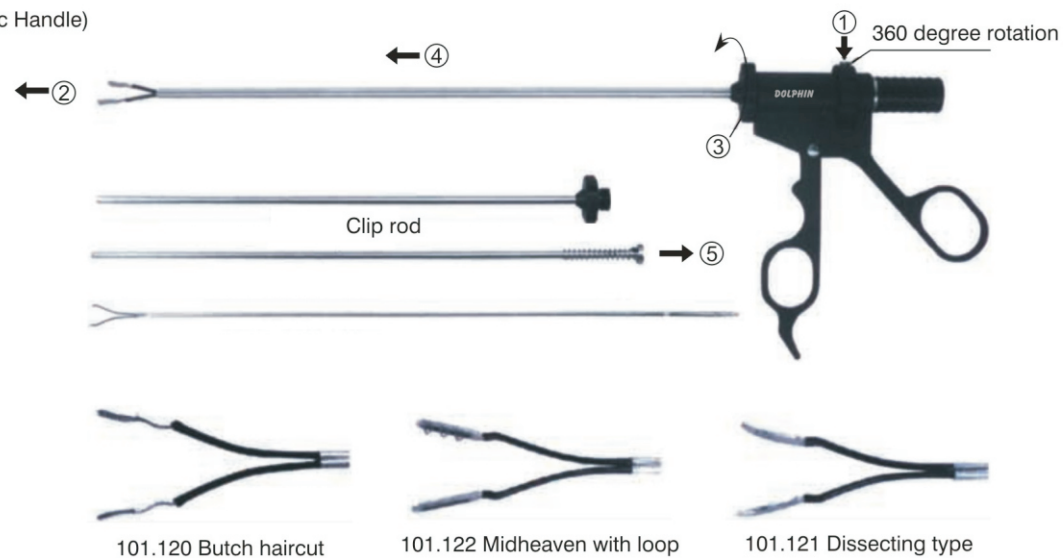

101.117 **Bipolar Clip** (Straight)
Ø 5 x 330 mm



101.119 Sideway



101.121 Bending



101.123 Hollow

LAPAROSCOPE INSTRUMENTS



Double Electrode Wine
Ø 5 x 330 mm



Double Action Atraumatic



Double Action Dissecting



101.126 Bipolar Electro Coagulation Cable
3000mm



101.133 Suction & Irrigation Rod Ø 5 x 330 mm

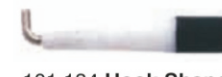

101.134 Hook Shape
Ø 5 x 330 mm



101.134 A- Hook Shape
Ø 5 x 330 mm



101.135 A-Hook Shape
Ø 5 x 330 mm



101.135 Hook shape
Ø 5 x 330 mm



101.136 Rod shape
Ø 5 x 330 mm



101.181 Ball shape
(Coagulation) Ø 5 x 330 mm



101.137 Shovel shape
Ø 5 x 330 mm



101.138 Needle shape
Ø 5 x 330 mm



101.180 Knife shape
Ø 5 x 330 mm



101.130 Push Type Valve
Ø 5/Ø 10 x 330 mm
Ø 2.8 x 330 mm
Ø 5 x 210 mm



101.131 Knob-Operated Control
Ø 5/Ø 10 x 330 mm



101.076 Fan-Shaped Forceps
Ø 5 x 330 mm

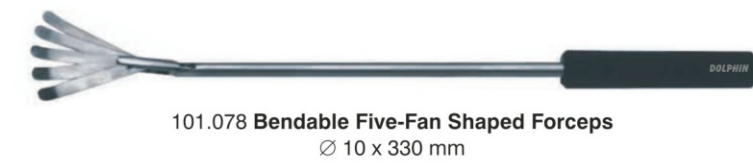

101.078 Bendable Five-Fan Shaped Forceps
Ø 10 x 330 mm

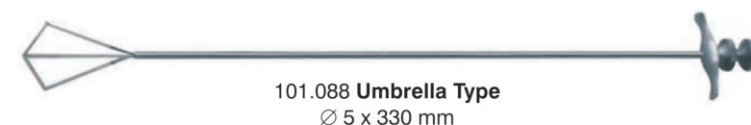

101.088 Umbrella Type
Ø 5 x 330 mm

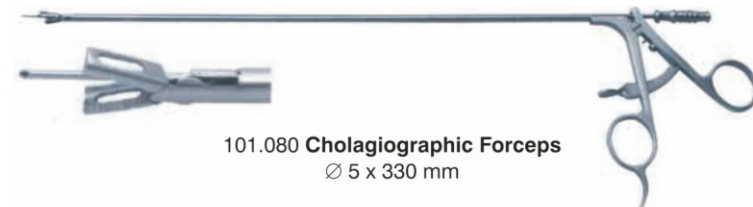

101.080 Cholagiographic Forceps
Ø 5 x 330 mm

LAPAROSCOPE KIT

DOLPHIN
INSTRUMENTS

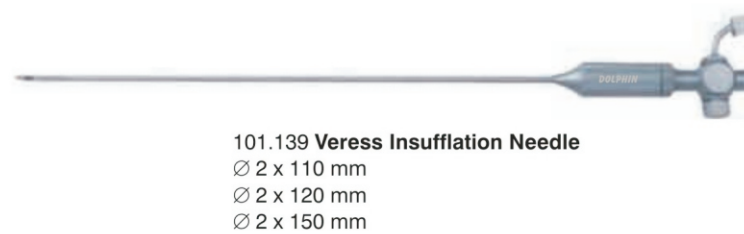
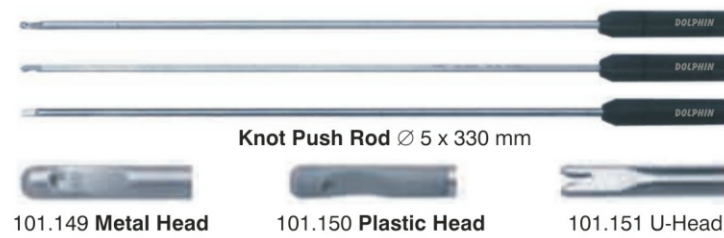
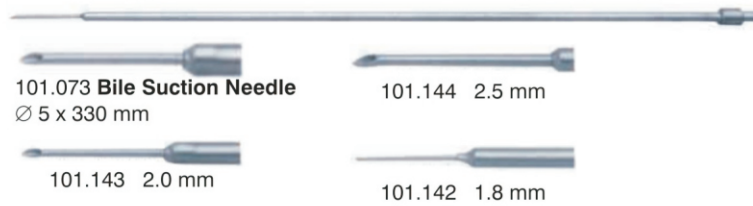
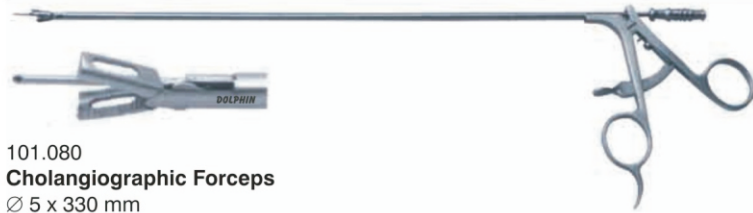

LAPAROSCOPY & UROLOGY INSTRUMENTS

LAPAROSCOPE ACCESSORIES



CCD Camera



501.005
LED Light Source



501.007
Irrigation Pump



501.006
Suction Irrigation Appliance



501.002
CO₂ Insufflator



501.003
Smart 4 Plus

HYSTEROSCOPY

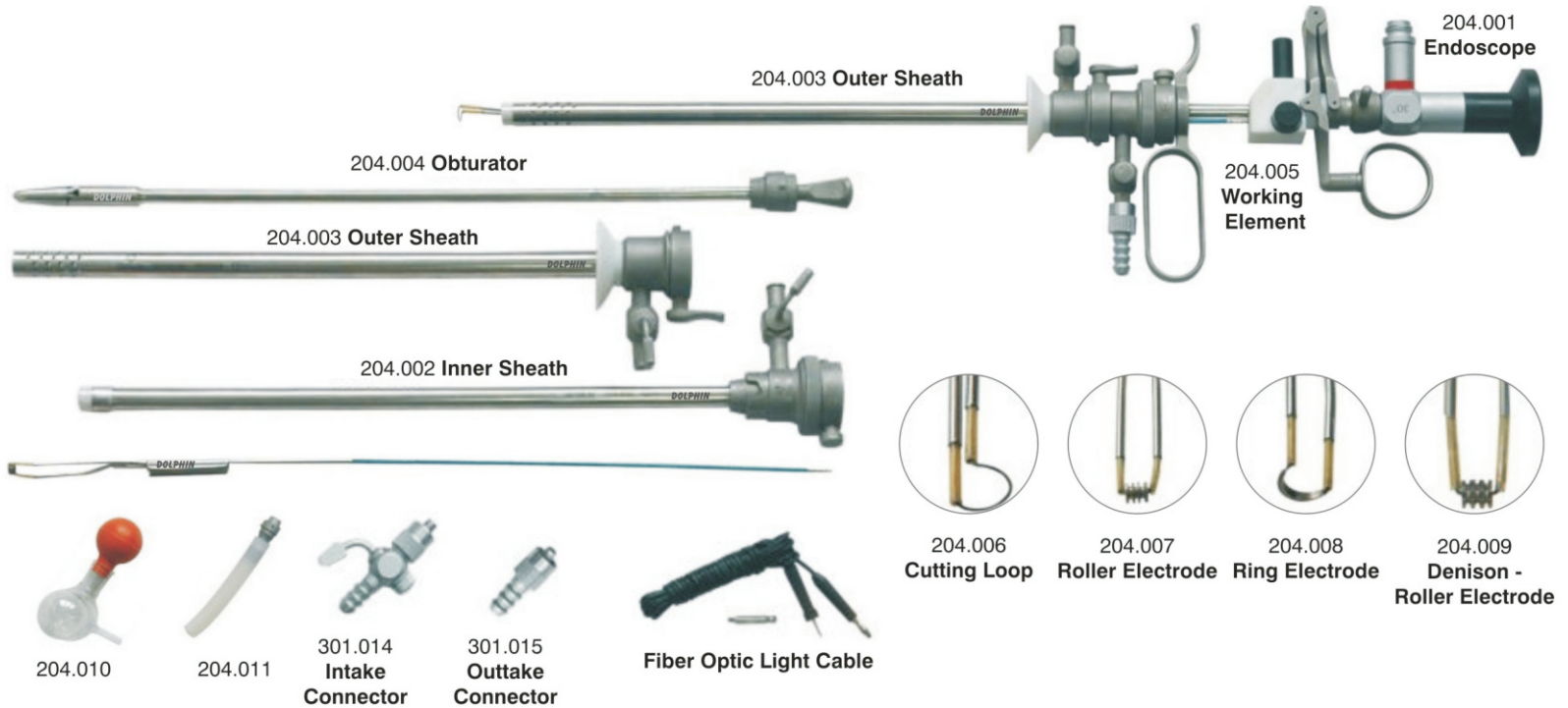

204.001
Endoscope

204.003 Outer Sheath

204.004 Obturator

204.005
Working
Element

204.003 Outer Sheath

204.002 Inner Sheath



204.006
Cutting Loop

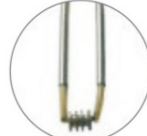

204.007
Roller Electrode



204.008
Ring Electrode



204.009
Denison -
Roller Electrode



204.010



204.011



301.014
Intake
Connector



301.015
Outtake
Connector



Fiber Optic Light Cable

URETHRO CYSTOSCOPY SET



- A0022.1 30° Endoscope**
Ø3 x 320 mm
1. Connecting to TIANSONG light guide cable
Connecting to OLYMPUS light guide cable
Connecting to STORZ light guide cable
 2. Connecting to WOLF light guide cable
 3. Connecting to ACMI, STRYKER light guide cable



F1117 Operating Inner Sheath



F1116 Outer Sheath 30° 16.5 Fr



F4001.2 Long Needle



A 4010.1 Cleaning Brush Ø1 x 340 mm



F 1110.1 Biopsy Operating Forceps Rigid
5Fr x 340 mm

F 1113.1 Scissors Rigid
5Fr x 340 mm

F 2107.2 Loop Catching Forceps Rigid
5Fr x 340 mm

ARTHROSCOPE

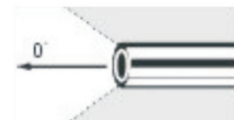

D 205-101 0° Endoscope



D 205-102 30° Endoscope



D 205-103 70° Endoscope



D 801-101



D 801-104



D 801-104



D 801-113



D 801-113



D 801-113

ARTHROSCOPE

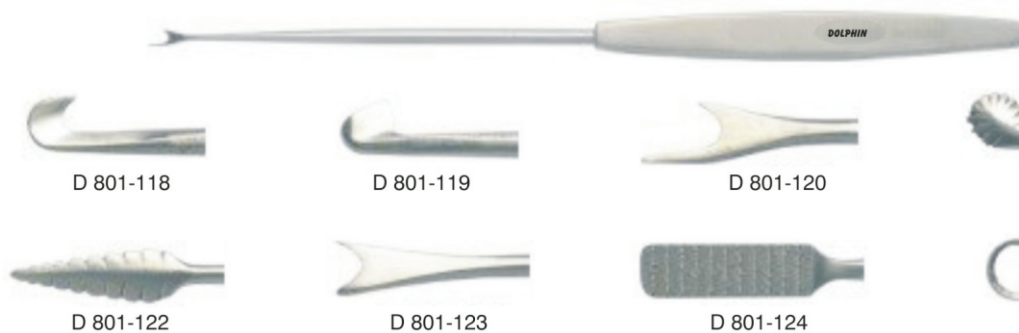

CYSTOSCOPE

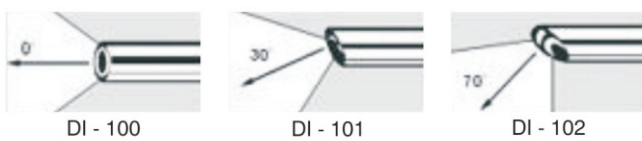
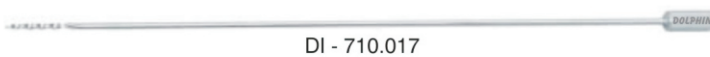
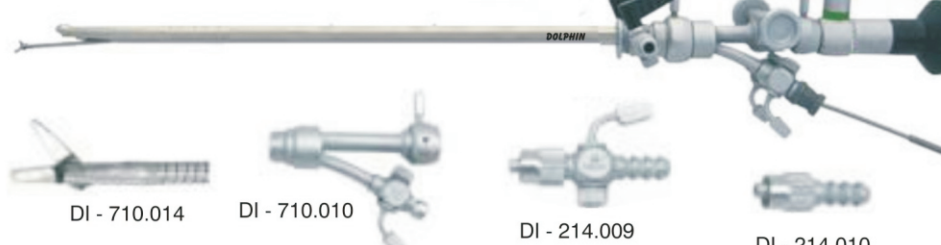

**DOLPHIN
INSTRUMENTS**

**DOLPHIN
STEEL CRAFT**

**DOLPHIN
SURGICALS**



We shape the steel to serve humanity...

**DOLPHIN
SURGICAL
HOUSE**

**VARUN
SURGICALS**

**ROMEX
ORTHOTICS**



**DOLPHIN
INSTRUMENTS**

Ravi Raj Industries Gala No. 33, Behind Dharam Kanta,
Near Janseva Shakari Bank, Phatak Road, Bhayander (E),
Thane, Maharashtra - 401105
Cell: + (91)-9892648331 / 9892648332
Telephone: + (91)-(22)-28173131 / 28043031
Fax: + (91)-(11)-47619705  skype: navin_giri
Email: dolphinsurgical_83@yahoo.in
Website: www.dolphinsurgical.com

